

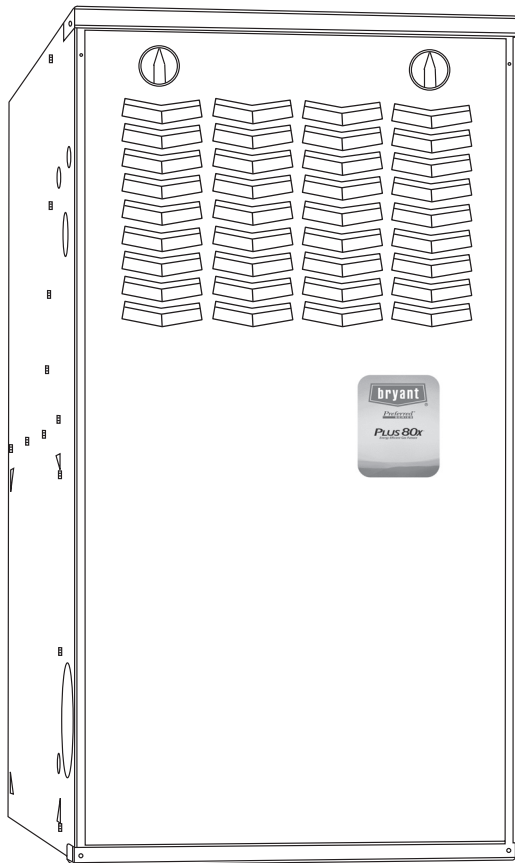

## Product Data



A10256

### THE BRYANT *Plus* 80x GAS FURNACE

The *Plus* 80x Deluxe 4-Way Multipoise Gas Furnace offers outstanding features in an 80% AFUE furnace.

Deluxe features include: an ECM motor which enhances SEER performance up to 1.5 points\*, a third fan relay for discrete continuous fan speed, the ability to change continuous fan speeds from the thermostat (Fan on *Plus*™), dehumidify mode, fault code storage, and more. The *Plus* 80x is very quiet thanks to a new combustion design that eliminates noise, rather than just muffle or box it in. Applications are easy with 4-way multipoise design, through-the-furnace downflow venting, 13 different venting options, and an overall design for easy service access. An inner blower door is provided for tighter sealing in sensitive applications. The 313JAV is approved for use in Low NOx Air Quality Management Districts.

\*as compared to the Air Conditioning Heating and Refrigeration Institute's standard coil—only ratings when paired with selected Bryant evaporator coils.

### STANDARD FEATURES

- ECM blower motor included
- Noise elimination combustion system
- SmartEvap™ can lower the humidity level in the home by nearly 10%
- Certified to leak 2 percent or less of its nominal air conditioning CFM delivered when pressurized to 1-In. Water Gauge with all present air inlets, air outlets, and condensate drain port(s) sealed.
- Four-position furnace: Upflow, Horizontal Right, Horizontal Left, Downflow  
Thirteen different vent options
- Compact design only 33-1/3 in. (847 mm) tall
- Microprocessor based “smart” control center  
Fan on *Plus*™ - Continuous Fan speed adjustable from thermostat  
Adjustable heating air temperature rise  
Dehumidify mode  
Enhanced diagnostics with LED and reflective sight glass, non-volatile fault code memory, and self-test feature  
On-board fuse for transformer protection
- Patented blocked vent safeguard to ensure proper furnace venting
- Insulated blower compartment
- HYBRID HEAT® Dual Fuel System compatible
- All models are chimney friendly when used with accessory vent kit
- Perfect Light™ Igniter
- Residential installations eligible for consumer financing through the Comfort Credit Program

# BRYANT ACCESSORIES

313AAV/JAV

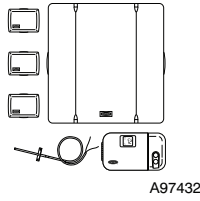

A97432

### CONTROLS: THERMOSTATS AND ZONING

Available in programmable and non-programmable models, Bryant thermostats maintain a constant, comfortable temperature level in the home.

For the ultimate in home comfort, Bryant's 2, 4, and 8-zone systems allow temperature control of individual "zones" of the home. This is accomplished through a series of electronic dampers and remote room sensors. The 4-zone system is shown.

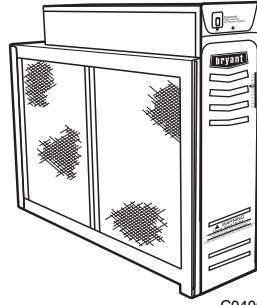

C04009

### MECHANICAL OR ELECTRONIC AIR CLEANER

Cleans the air of smoke, dirt, and many pollens commonly found. Saves decorating and cleaning expenses by keeping carpets, furniture, and drapes cleaner.

Electronic air cleaner is shown.

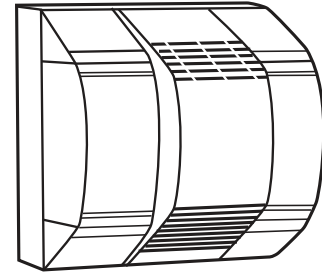

A01484

### MODEL HUMCCLFP HUMIDIFIER

By adding moisture to winter-dry air, a Bryant humidifier can often improve comfort and keep furniture, rugs, and draperies in better condition. Moisturizing household air also helps to retain normal body heat and provides comfort at lower temperatures.

A08153

ACCESSORIES	
ELECTRONIC AIR CLEANER (EAC)	Model EACB
AIR PURIFIER	Models GAPAXBB1625, GAPAXBB2025
MECHANICAL AIR CLEANER	Models EZXCAB, FILCAB
HUMIDIFIER	Model HUM
HEAT RECOVERY VENTILATOR	Model HRV
ENERGY RECOVERY VENTILATOR	Model ERV
UV LIGHTS	Model UVL
THERMOSTAT – NON-PROGRAMMABLE	For use with 1-speed Air Conditioner – deg. F/C, Auto Changeover – T6-NAC, T2-NAC
	For use with 1-speed Heat Pump – deg. F/C, Auto Changeover – T6-NHP, T2-NHP*
	For use with 2-speed Air Conditioner – deg. F/C, Auto Changeover – T6-NRH*
	For use with multi-use / stage configurations – deg. F/C, Auto Changeover/Temperature and Humidity Control – T6-PRH†
THERMOSTAT – PROGRAMMABLE	For use with 1-speed Air Conditioner – deg. F/C, Auto Changeover, 7-Day Programmable – T6-PAC
	For use with 1-speed Heat Pump – deg. F/C, Auto Changeover, 7-Day Programmable – T6-PHP*
	For use with 2-speed Air Conditioner – deg. F/C, Auto Changeover, 7-Day Programmable – T6-PRH*
	For use with 1-speed Air Conditioner – deg. F/C, 5-2 Day Programmable – T6-PAC
	For use with multi-stage applications – deg. F/C, Auto Changeover, 7-Day Programmable – T2-PHP‡
	For multi-use / stage configurations – deg. F/C, Auto Changeover, 7-Day Programmable/Temperature and Humidity Control – T6-PRH†
ZONING CONTROL	Zone Perfect 3-Zone kit – ZONEBB3ZAC01, ZONEBB3ZHP01
	2-Zone Perfect Plus kit/Temperature and Humidity Control – ZONEBB2KIT01-B
	4-Zone Perfect Plus kit/Temperature and Humidity Control – ZONEBB4KIT01-B
	8-Zone Perfect Plus kit/Temperature and Humidity Control – ZONEBB8KIT01-B

\*Model HP and 2S thermostat must be field converted to air conditioner operation.

†Thermidistat™ Control can be configured for multiple use and staging. It must be configured for each specific application.

‡Dual Fuel thermostat is used with furnace and heat pump application.

# BRYANT ACCESSORIES

DESCRIPTION 313AAV/JAV	PART NO.	024045	048070	048090	060110	060135
Media Filter Cabinet	FILCABBB0016	X	X			
	FILCABBB0020			X	X	
	FILCABBB0024					X
Cartridge Media Filter	FILBBCAR0016	X	X			
	FILBBCAR0020			X	X	
	FILBBCAR0024					X
EZ Flex Media Filter with End Caps	EXPXXUNV0016	X	X			
	EXPXXUNV0020			X	X	
	EXPXXUNV0024					X
Replacement EZ Flex Filter Media	EXPXXFIL0016	X	X			
	EXPXXFIL0020			X	X	
	EXPXXFIL0024					X
External Bottom Return	KGAFR0401B14	X				
	KGAFR0501B17		X			
Filter Rack	KGAFR0601B21			X	X	
	KGAFR0701B24					X
External Side Return Filter Rack	KGAFR0801SRE	X	X	X	X	X
Unframed Filter 3/4-in. (19 mm)	KGAWF1306UFR †	X	X			
	KGAWF1406UFR			X	X	
	KGAWF1506UFR					X
Flue Extension	KGAFE0112UPH	X	X	X	X	X
Combustible Floor Base	KGASB0201ALL	X	X	X	X	X
Downflow Vent Guard	KGBVG0101DFG	X	X	X	X	X
Vent Extension Kit	KGAVE0101DNH	X	X	X	X	X
Chimney Adapter Kit	KGACA02014FC	X	X	X	X	
Chimney Adapter Kit	KGACA02015FC					X
Natural – to – Propane Conversion Kit*	KGANP4601ALL	X	X	X	X	X
Propane – to – Natural Conversion Kit*	KGAPN3901ALL	X	X	X	X	X
Label Kit	KGALB0101KIT	X	X	X	X	X
Gas Orifice	LH32DB207	See Installation Instructions for model, altitude, and heat value usages.				
	LH32DB202					
	LH32DB200					
	LH32DB205					
	LH32DB208					
	LH32DB078					
	LH32DB076					
	LH32DB203					
	LH32DB201					
	LH32DB206					
	LH32DB209					
	LH32DB210					

313AAV/JAV

\*Factory – authorized and field – installed. Gas conversion kits are CSA (AGA/CGA) recognized.

†Suitable for Side Return Filter Rack.

X – Accessory

S – Standard

## PHYSICAL DATA

UNIT SIZE		024045	048070	048090	060110	060135
OUTPUT CAPACITY BTUH (Non-weatherized ICS)	313JAV Upflow; all 313AAV	36,000	53,000	72,000	90,000	107,000
	313JAV Downflow/Horizontal	34,000	51,000	69,000	86,000	102,000
INPUT BTUH	313JAV Upflow; all 313AAV	44,000	66,000	88,000	110,000	132,000
	313JAV Downflow/Horizontal	42,000	63,000	84,000	105,000	126,000
AFUE%	Non-weatherized ICS	80.0	80.0	80.0	80.0	80.0
SHIPPING WEIGHT LB. (KG)		104 (47)	126 (57)	140 (64)	152 (69)	163 (74)
CERTIFIED TEMP RISE RANGE °F (°C)		30-60 (17-33)	25-55 (14-31)	35-65 (19-36)	30-60 (17-33)	40-70 (22-39)
CERTIFIED EXT STATIC PRESSURE (IN. In. W.C.)	Heating	0.10	0.12	0.15	0.20	0.20
	Cooling	0.50	0.50	0.50	0.50	0.50
AIRFLOW CFM	Heating	735	1230	1345	1890	1865
	Cooling	1035	1460	1665	2040	2070
LIMIT CONTROL		SPST				
HEATING BLOWER CONTROL		Solid-State Time Operation				
BURNERS (Monoport)		2	3	4	5	6
GAS CONNECTION SIZE		1/2-in. NPT				
GAS VALVE(Redundant) Manufacturer		White-Rodgers				
Minimum Inlet Pressure (In. W.C.)		4.5 (Natural Gas)				
Maximum Inlet Pressure (In. W.C.)		13.6 (Natural Gas)				
IGNITION DEVICE		Hot Surface				

\*Gas input ratings are certified for elevations to 2000 ft. (610 M)\*. In USA, For elevations above 2000 ft. (610 M), reduce ratings 4 percent for each 1000 ft. (305 M) above sea level. Refer to National Fuel Gas Code NFPA 54/ANSI Z223.1-2009 Table F.4 or furnace Installation Instructions.

†Capacity in accordance with U.S. Government DOE test procedures.

‡Airflow shown is for bottom only return-air supply. For air delivery above 1800 CFM, see Air Delivery Table for other options. A filter is required for each return-air supply. An airflow reduction of up to 7 percent may occur when using a Bryant 4-5/16 in. (110 mm) high efficiency media filter.

ICS - Isolated Combustion System

313AAV/JAV

## BLOWER PERFORMANCE DATA

UNIT SIZE	024045	048070	048090	060110	060135
DIRECT-DRIVE MOTOR Hp (ECM - 5 Speed)	1/2	3/4	3/4	1	1
MOTOR FULL LOAD AMPS	6.8	8.8	8.8	11.5	11.5
RPM (Nominal) - SPEEDS	1050 - 5	1050 - 5	1050 - 5	1050 - 5	1050 - 5
BLOWER WHEEL DIAMETER x WIDTHS - IN (MM)	10 x 6 (254 x 152)	11 x 8 (279 x 203)	10 x 10 (254 x 254)	11 x 11 (279 x 279)	11 x 11 (279 x 279)

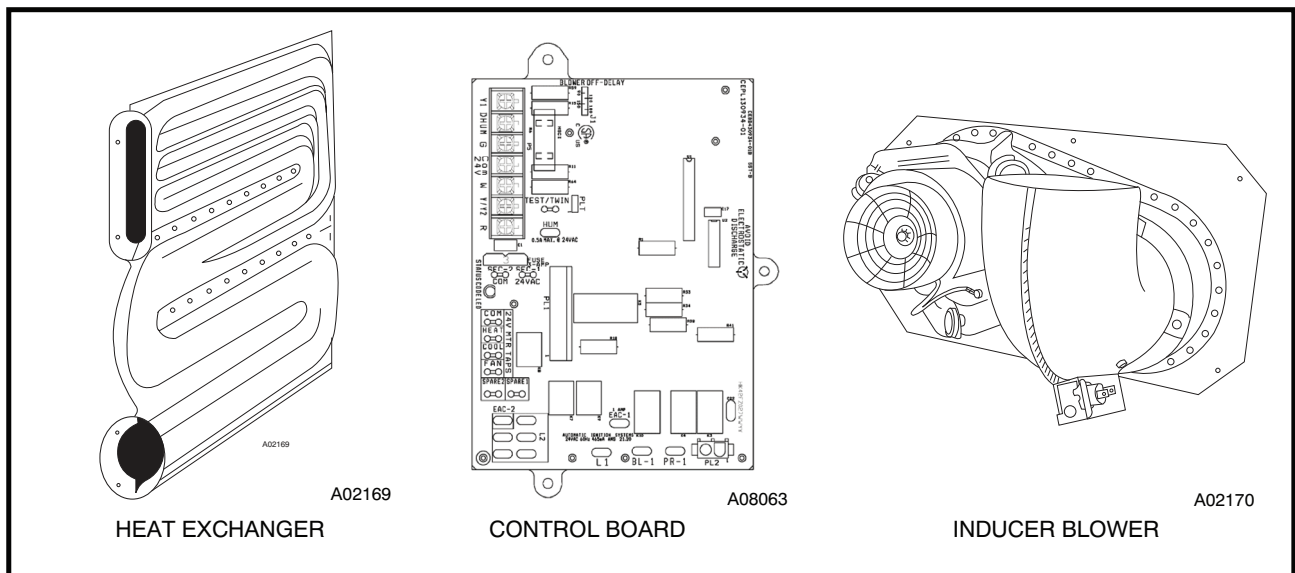

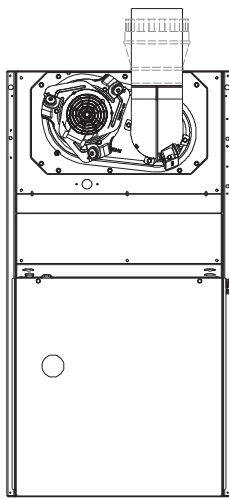

SEE NOTES: 1,2,4,7,8,9  
UPFLOW  
A02058

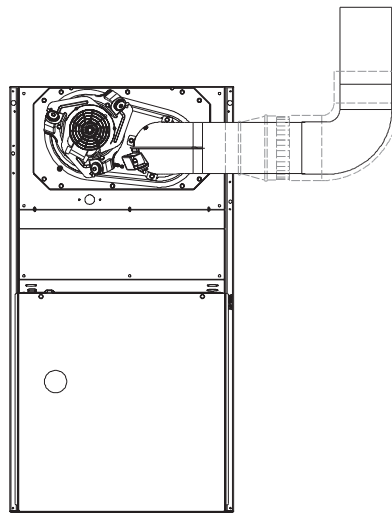

SEE NOTES: 1,2,3,4,7,8,9  
UPFLOW  
A02059

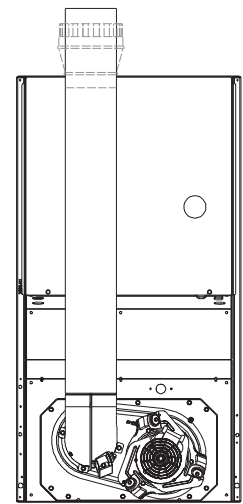

SEE NOTES: 1,2,4,5,7,8,9  
DOWNFLOW  
A02061

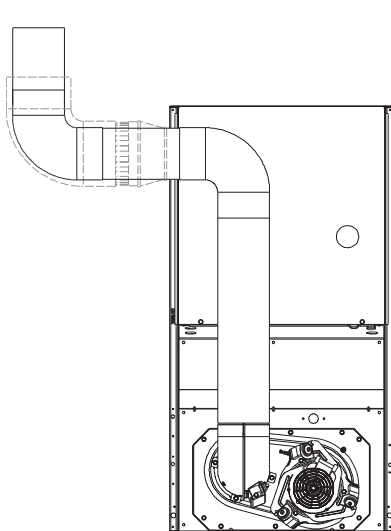

SEE NOTES: 1,2,3,4,5,7,8,9  
DOWNFLOW  
A02060

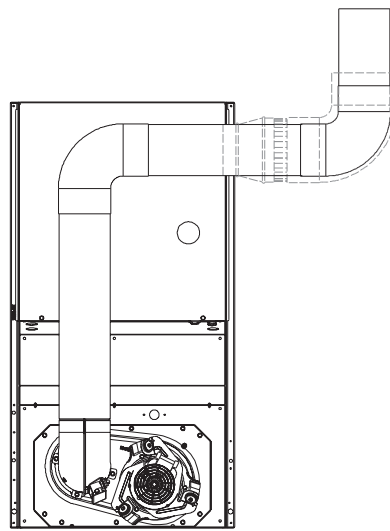

SEE NOTES: 1,2,3,4,7,8,9  
DOWNFLOW  
A02063

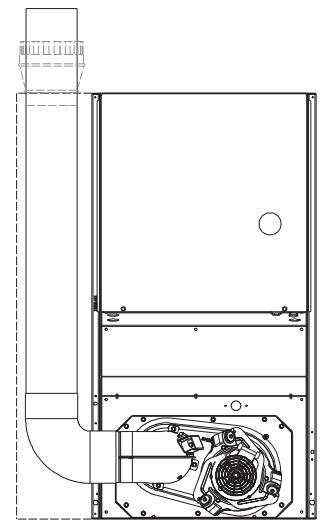

SEE NOTES: 1,2,4,5,6,7,8,9  
DOWNFLOW  
A02062

313AAV/JAV

## Venting Notes

1. For common vent, vent connector sizing and vent material: United States, latest edition of the National Fuel Gas Code (NFPA54/ANSI Z223.1).
2. Immediately increase to 5-in. (127 mm) vent connector outside furnace casing when 5-in. (127 mm) vent connector required, refer to Note 1.
3. Side outlet vent for upflow and downflow installations must use Type B vent immediately after exiting the furnace, except when Downflow Vent Guard is used in downflow position.
4. Type B vent where required, refer to Note 1.
5. 4-in. (102 mm) single wall vent must be used inside furnace casing and the Downflow Vent Guard Kit.
6. Accessory Downflow Vent Guard Kit required in downflow installations with bottom vent configuration.
7. Chimney Adapter Kit required for exterior masonry chimney applications. Refer to Chimney Adapter Kit for sizing and complete application details.
8. Secure vent connector to furnace elbow with (2) corrosion-resistant sheet metal screws, space approximately 180° apart.
9. Secure all other single wall vent connector joints with (3) corrosion-resistant screws spaced approximately 120° apart. Secure Type B vent connectors per vent connector manufacturer's recommendations.

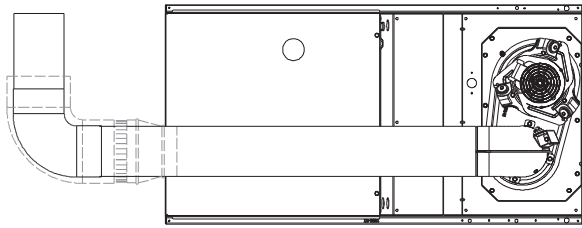

SEE NOTES: 1,2,4,5,7,8,9  
HORIZONTAL RIGHT

A02068

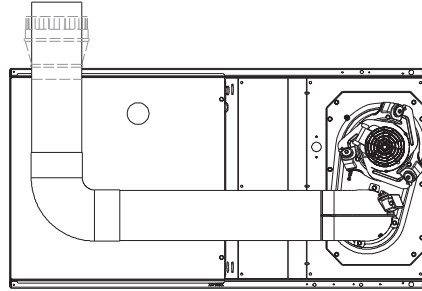

SEE NOTES: 1,2,4,5,7,8,9  
HORIZONTAL RIGHT

A02070

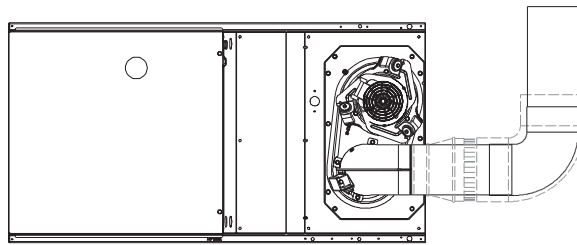

SEE NOTES: 1,2,4,7,8,9  
HORIZONTAL RIGHT

A02069

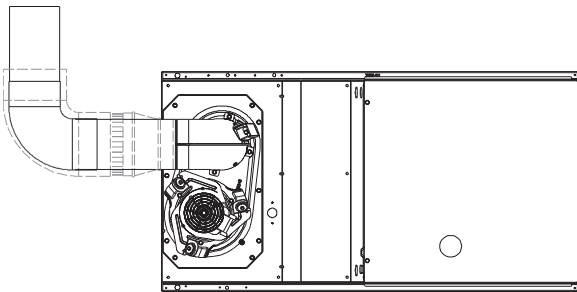

SEE NOTES: 1,2,4,7,8,9  
HORIZONTAL LEFT

A02064

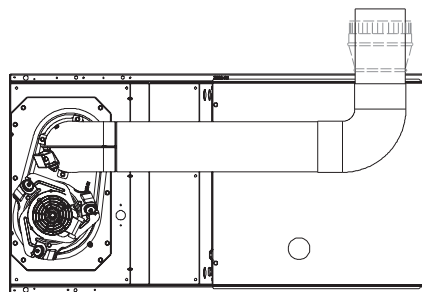

SEE NOTES: 1,2,4,5,7,8,9  
HORIZONTAL LEFT

A02065

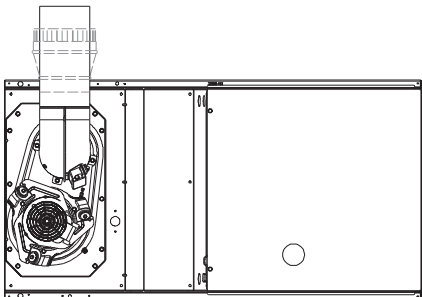

SEE NOTES: 1,2,4,5,7,8,9  
HORIZONTAL LEFT

A02066

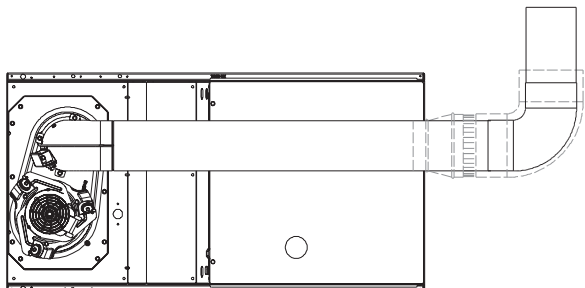

SEE NOTES: 1,2,4,5,7,8,9  
HORIZONTAL LEFT

A02067

## AIR DELIVERY - CFM (WITH FILTER)\*

UNIT SIZE	COLOR	SPEED	EXTERNAL STATIC PRESSURE (In. W.C.)									
			0.1	0.2	0.3	0.4	0.5	0.6	0.7	0.8	0.9	1
024045	Gray	5	1185	1145	1115	1075	1035	980	905	820	720	580
	Yellow	4	920	880	835	800	755	720	680	645	605	540
	Blue	3	735	685	625	585	530	490	435	395	345	295
	Orange	2	820	765	725	670	630	580	545	490	455	405
	Red	1	650	595	535	490	430	390	330	280	235	--
048070	Gray	5	1625	1585	1535	1495	1460	1415	1365	1295	1220	1125
	Yellow	4	1405	1360	1320	1280	1240	1195	1155	1115	1070	1030
	Blue	3	1240	1200	1155	1110	1065	1020	975	935	895	850
	Orange	2	1190	1140	1095	1050	1000	955	915	870	830	790
	Red	1	1035	985	930	885	835	785	745	695	650	600
048090	Gray	5	1845	1800	1755	1710	1665	1595	1500	1400	1275	1105
	Yellow	4	1590	1545	1500	1455	1410	1365	1315	1270	1180	1000
	Blue	3	1365	1320	1270	1215	1170	1125	1070	1025	955	900
	Orange	2	1225	1160	1110	1060	1010	950	895	830	770	710
	Red	1	1100	1030	960	875	805	730	645	570	505	425
060110	Gray	5	2255	2205	2150	2100	2040	1985	1920	1835	1735	1615
	Yellow	4	1600	1525	1465	1400	1335	1275	1210	1150	1080	1015
	Blue	3	1945	1890	1830	1770	1715	1655	1600	1545	1480	1430
	Orange	2	1420	1340	1280	1200	1140	1065	1005	925	865	790
	Red	1	1280	1205	1140	1055	990	910	840	760	695	630
060135	Gray	5	2295	2240	2185	2125	2070	2005	1925	1805	1670	1545
	Yellow	4	1725	1660	1605	1545	1460	1395	1340	1285	1230	1170
	Blue	3	1910	1865	1800	1745	1685	1610	1545	1485	1435	1380
	Orange	2	1630	1575	1510	1435	1365	1300	1245	1185	1130	1065
	Red	1	1430	1355	1285	1200	1125	1075	1015	945	855	800

\*A filter is required for each return-air inlet. Airflow performance included 3/4-in. (19 mm) washable filter media such as contained in factory-authorized accessory filter rack. To determine airflow performance without this filter, assume an additional 0.1 In. W.C. available external static pressure.

-- Indicates unstable operating conditions.

## ELECTRICAL DATA

FURNACE MODEL	VOLTS-HERTZ-PHASE	OPERATING VOLTAGE* (VOLTS)		MAX UNIT (AMPS)	UNIT AMPACITY# (AMPS)	MAX WIRE LENGTH‡ (FT. (M))	MAX FUSE/CKT BKR† (AMPS)	MIN WIRE GAGE
		MAX	MIN					
024045	115 - 60 - 1	127	104	8.1	10.9	34 (10)	15	14
048070	115 - 60 - 1	127	104	10.8	14.2	26 (8)	15	14
048090	115 - 60 - 1	127	104	11.4	14.8	25 (7)	15	14
060110	115 - 60 - 1	127	104	14.2	18.2	31 (9)	20	12
060135	115 - 60 - 1	127	104	14.2	18.2	31 (9)	20	12

\* Permissible limits of the voltage range at which the unit operates satisfactorily.

† Time-delay type is recommended.

‡Length shown is as measured 1 way along wire path between unit and service panel for maximum 2 percent voltage drop.

313AAV/JAV

# DIMENSIONS

313AAV/JAV

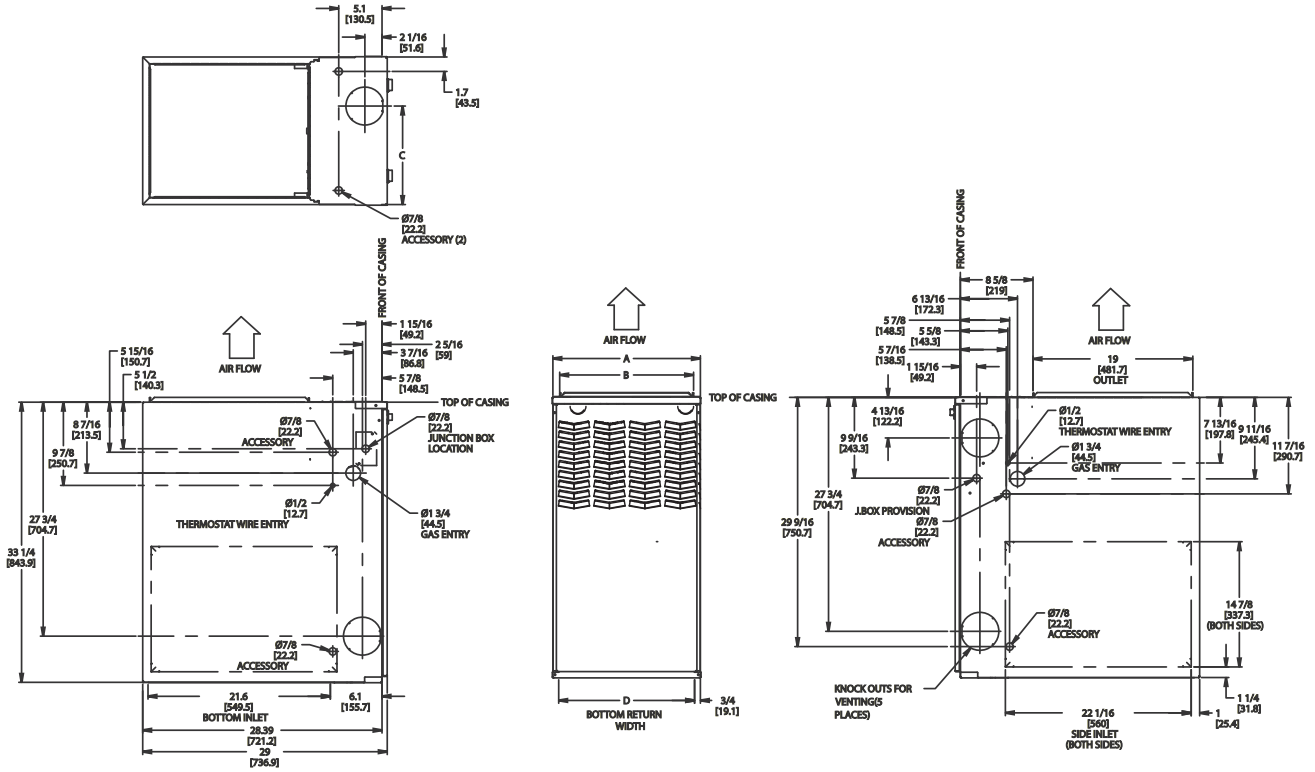

A10271

1. Two additional 7/8-in. (22 mm) dia. knockouts are located in the top plate.
2. Minimum return-air openings at furnace, based on metal duct. If flex duct is used, see flex duct manufacturer's recommendations for equivalent diameters.
3. Minimum return-air opening at furnace.
  - a. For 800 CFM-16-in. (406 mm) round or 14-1/2 x 12-in. (368 x 305 mm) rectangle.
  - b. For 1200 CFM-20-in. (508 mm) round or 14-1/2 x 19-1/3 in. (368 x 491 mm) rectangle.
  - c. For 1600 CFM-22-in. (559 mm) round or 14-1/2 x 22-1/16-in. (368 x 560 mm) rectangle.
  - d. For airflow requirements above 1800 CFM, see Air Delivery table in Product Data literature for specific use of single side inlets. The use of both side inlets, a combination of 1 side and the bottom, or the bottom of single side inlets. The use of both side inlets, a combination of one side and the bottom, or the bottom only will ensure adequate return air openings for airflow requirements above 1800 CFM.

FURNACE SIZE	A CABINET WIDTH IN (MM)	B OUTLET WIDTH IN (MM)	C TOP & BOTTOM FLUE COLLAR IN (MM)	D BOTTOM INLET WIDTH IN (MM)	VENT CONNECTION SIZE	ACCESSORY MEDIA CABINET SIZE IN (MM)
024045	14-3/16 (360)	12-9/16 (319)	9-5/16 (237)	12-11/16 (322)	4	16 (406)
048070	17-1/2 (445)	15-7/8 (403)	11-9/16 (294)	16-1/8 (410)	4	16 (406)
048090	21 (533)	19-3/8 (492)	13-5/16 (338)	19-1/2 (495)	4	20 (508)
060110	21 (533)	19-3/8 (492)	13-5/16 (338)	19-1/2 (495)	4	20 (508)
060135	24-1/2 (622)	22-7/8 (581)	15-1/16 (383)	23 (584)	4*	24 (610)

\*135 size furnaces require a 5 or 6-in. (127 or 152 mm) vent. Use a vent adapter between furnace and vent stack. See Installation Instructions for complete installation requirements.



**⚠ WARNING**

**FIRE, EXPLOSION, ASPHYXIATION HAZARD**

Improper adjustment, alteration, service, maintenance, or installation can cause serious injury or death.

Read and follow instructions and precautions in User's Information Manual provided with this furnace. Installation and service must be performed by a qualified service agency or the gas supplier.

**⚠ CAUTION**

Check entire gas assembly for leaks after lighting this appliance.

**INSTALLATION**

1. This furnace must be installed in accordance with the manufacturer's instructions and local codes. In the absence of local codes, follow the National Fuel Gas Code ANSI Z223.1 / NFPA54 or CSA B-149. 1 Gas Installation Code.
2. This furnace must be installed so there are provisions for combustion and ventilation air. See manufacturer's installation information provided with this appliance.

**OPERATION**

This furnace is equipped with manual reset limit switch(es) in burner compartment to protect against overheat conditions that can result from inadequate combustion air supply or blocked vent conditions.

1. Do not bypass limit switches.
2. If a limit opens, call a qualified serviceman to correct the condition and reset limit switch.

**INSTALLATION**

**MINIMUM INCHES CLEARANCE TO COMBUSTIBLE CONSTRUCTION**

This forced air furnace is equipped for use with natural gas at altitudes 0 - 10,000 ft (0 - 3,050m). An accessory kit, supplied by the manufacturer, shall be used to convert to propane gas use or may be required for some natural gas applications.

This furnace is for indoor installation in a building constructed on site.

This furnace may be installed on combustible flooring in alcove or closet at minimum clearance as indicated by the diagram from combustible material.

This furnace may be used with a Type B-1 Vent and may be vented in common with other gas fired appliances.

This furnace is approved for UPFLOW, DOWNFLOW, and HORIZONTAL installations.

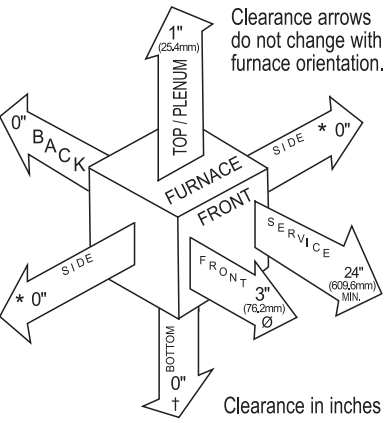

**Vent Clearance to combustibles:**  
 For Single Wall vents 6 inches (6 po).  
 For Type B-1 vent type 1 inch (1 po).

**MINIMUM INCHES CLEARANCE TO COMBUSTIBLE CONSTRUCTION**

**DOWNFLOW POSITIONS:**

- † Installation on non-combustible floors only.  
 For Installation on combustible flooring only when installed on special base, Part No. KGASB0201ALL or NAHA01101SB, Coil Assembly, Part No. CAR, CAP, CNPV, CNRV, END4X, ENW4X, WENC, WTNC, WENW OR WTNW.
- ∅ 18 inches front clearance required for alcove.
- \* Indicates supply or return sides when furnace is in the horizontal position. Line contact only permissible between lines formed by intersections of the Top and two Sides of the furnace jacket, and building joists, studs or framing.



336996-101 REV. C

313AAV/JAV

A10269



Use of the AHRI Certified TM Mark indicates a manufacturer's participation in the program. For verification of certification for individual products, go to [www.ahridirectory.org](http://www.ahridirectory.org).



**Always Ask For FACTORY AUTHORIZED PARTS**

# TYPICAL WIRING SCHEMATIC

- FIELD 24-V WIRING
- FIELD 115-, 208/230-, 460-V WIRING
- FACTORY 24-V WIRING
- FACTORY 115-V WIRING

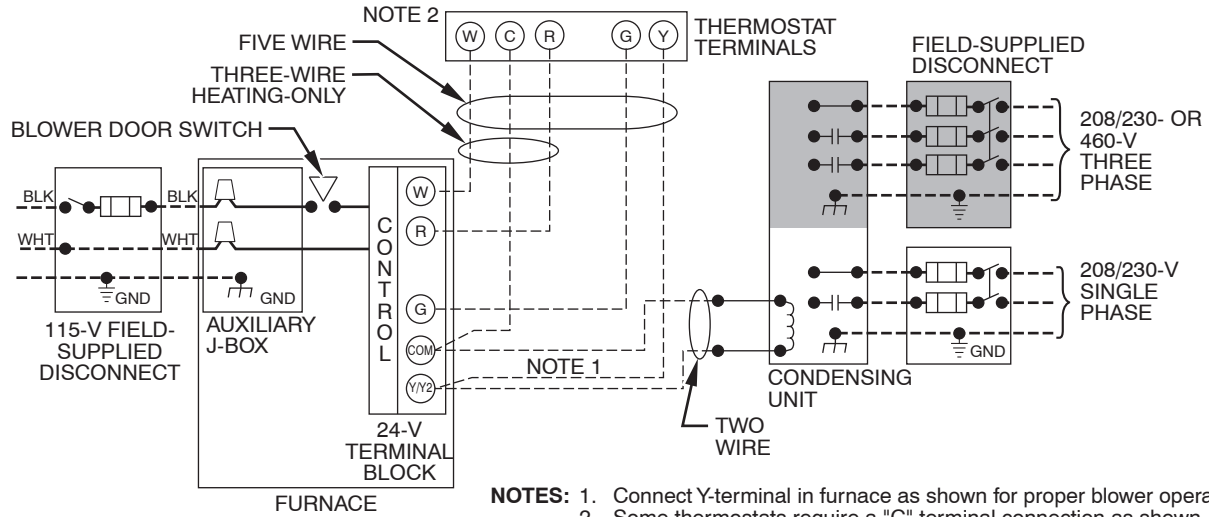

- NOTES:**
1. Connect Y-terminal in furnace as shown for proper blower operation.
  2. Some thermostats require a "C" terminal connection as shown.
  3. If any of the original wire, as supplied, must be replaced, use same type or equivalent wire.

A99440

313AAV/JAV

## MODEL NUMBER NOMENCLATURE

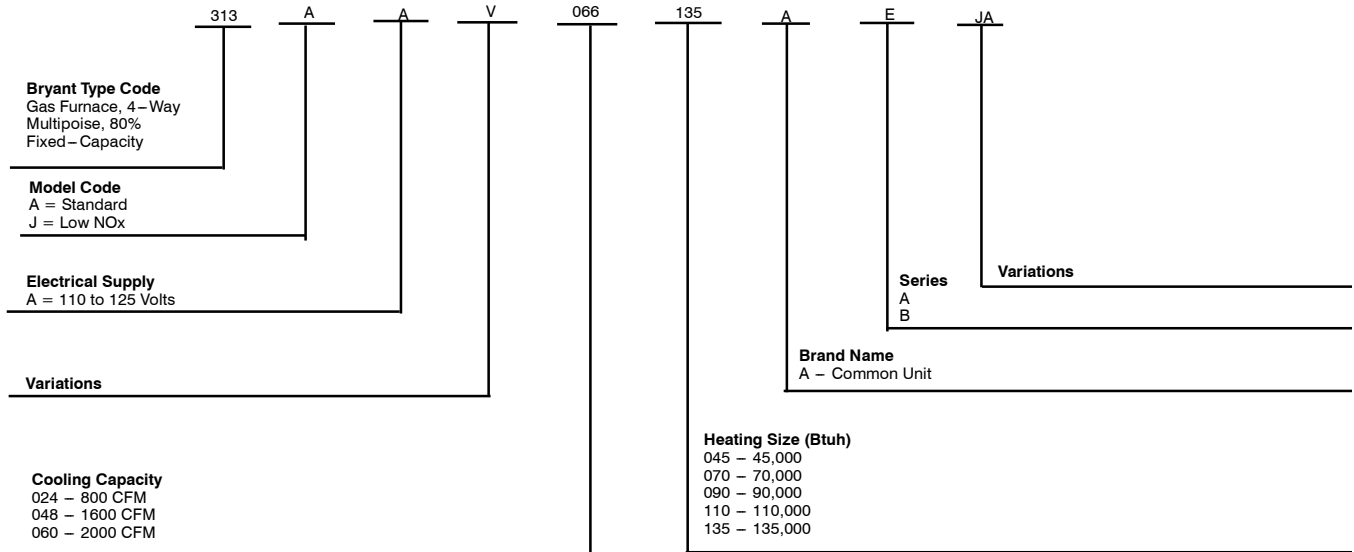

# GUIDE SPECIFICATIONS

## Gas Furnace

313AAV/JAV

## GENERAL

### System Description

Furnish a \_\_\_\_\_ fixed capacity gas-fired furnace for use with natural gas or propane (factory authorized conversion kit required for propane); furnish cold air return plenum.

### Quality Assurance

Unit will be designed, tested and constructed to the current ANSI Z 21.47/CSA 2.3 design standard for gas-fired central furnaces.

Unit will be 3rd party certified by CSA to the current ANSI Z 21.47/CSA 2.3 design standard for gas-fired central furnaces.

Unit will carry the CSA Blue Star® label.

Unit efficiency testing will be performed per the current DOE test procedure as listed in the Federal Register.

Unit will be certified for capacity and efficiency and listed in the latest AHRI Consumer's Directory of Certified Efficiency Ratings.

Unit will carry the current Federal Trade Commission Energy Guide efficiency label.

### Delivery, Storage and Handling

Unit shall be shipped as single package only and is stored and handled per unit manufacturer's recommendations.

### Warranty (for inclusion by specifying engineer)

U.S. only. Warranty certificate available upon request.

## PRODUCTS

### Equipment

Components shall include: slow-opening gas valve to reduce ignition noise, regulate gas flow, with electric switch gas shut-off; flame proving sensor, hot surface igniter, pressure switch assembly; flame rollout switch, blower and inducer assembly, 40va transformer; low-voltage (heating) (heating/ cooling) thermostat.

### Blower Wheel and Blower Motor

Galvanized blower wheel shall be centrifugal type, statically and dynamically balanced. Blower motor of ECM type shall be permanently lubricated with sealed bearings, of \_\_\_\_\_ hp, and shall be multiple-speed direct drive. Blower motor shall be soft mounted to the blower scroll to reduce vibration transmission.

### Filters

Furnace may have reusable-type filters. Filter shall be \_\_\_\_\_ in (x) \_\_\_\_\_ in. (mm). An accessory high-efficiency media filter is available as an option. \_\_\_\_\_ Media Filter.

### Casing

Casing shall be of .030 in. (.76 mm) thickness minimum, pre-painted galvanized steel.

### Inducer Motor

Inducer motor shall be soft mounted to reduce vibration transmission.

### Draft Safeguard Switch

Draft Safeguard Switch (blocked vent safeguard) shall be factory installed to reduce the possibility of vent gas infiltration due to a blocked or restricted vent pipe.

### Heat Exchangers

Heat exchangers shall be a 4-Pass 20 gage aluminized steel of fold-and-crimp sectional design when applied operating under negative pressure.

### Controls

Control shall include a micro-processor based integrated electronic control board with at least 11 service troubleshooting codes displayed via enhanced flashing LED diagnostic light on the control, a self-test feature that checks all major functions of the furnace within one minute, and a replaceable automotive-type circuit protection fuse. Multiple operational settings available including, separate blower speeds for heating, cooling and continuous fan. Continuous fan speed may be adjusted from the thermostat. Features will also include temporary reduced airflow in the cooling mode for improved dehumidification when a Thermostat™ Control is selected as the thermostat.

### Operating Characteristics

Heating Capacity shall be \_\_\_\_\_ Btuh input; \_\_\_\_\_ Btuh output capacity.

Fuel Gas Efficiency shall be 80% AFUE.

Air delivery shall be \_\_\_\_\_ CFM minimum at 0.50 In. W.C. external static pressure.

Dimensions shall be: depth \_\_\_\_\_ in.; width \_\_\_\_\_ in; height \_\_\_\_\_ in. (mm) (casing only). Height shall be \_\_\_\_\_ in. (mm) with A/C coil and \_\_\_\_\_ in. (mm) overall with plenum.

### Electrical Requirements

Electrical supply shall be 115 volts, 60 Hz, single-phase (nominal). Minimum wire size shall be \_\_\_\_\_ AWG; maximum fuse size or circuit breaker shall be \_\_\_\_\_ Amps.

### Special Features

Refer to section of the product data sheet identifying accessories and descriptions for specific features and available enhancements.

313AAV/JAV

